

LAMP. INSTALLATION MANUAL HES2S-150-A110 For SURFACE-MOUNT CONCEALED HINGE

Installation Video



Product Info



Selection Tool

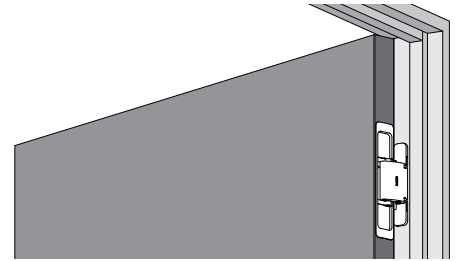

Left-hand opening shown.

Thank you for using our product. Before installation, please read this manual thoroughly to ensure correct installation. Please keep this manual at hand for future reference. For the most accuracy, please use metric measurements as they were converted to imperial measurements for reference.

ABOUT THE PRODUCT

- Concealed hinges for interior doors.
- Allows vertical, horizontal and depth adjustment.

DOOR SPECIFICATION

Door Thickness	Min. 35 mm [1-3/8"]
Max. Door weight	40kg[88 lbs] per 2 hinges, 50kg[110 lbs] per 3 hinges
Max. Door size	Width: 900 mm [35-7/16"], Height: 2700 mm [106-5/16"]

The required quantity of hinges depends on the stiffness and curvature of the door. Install the door and check to determine the appropriate amount of hinges.

COMPONENT PARTS (PER BOX)

Parts	①Body		②Cover		Fixing screw		Hex key 3mm	Template
	Door side		Jamb side		③Door side Truss head tapping screw 4×16	④Jamb side Countersunk head tapping screw 4×20		
Quantity	2	2	2	2	8 Steel	8 Stainless Steel	1	1

INSTALLATION DRAWING (EXAMPLE)

Unit: mm[inch]

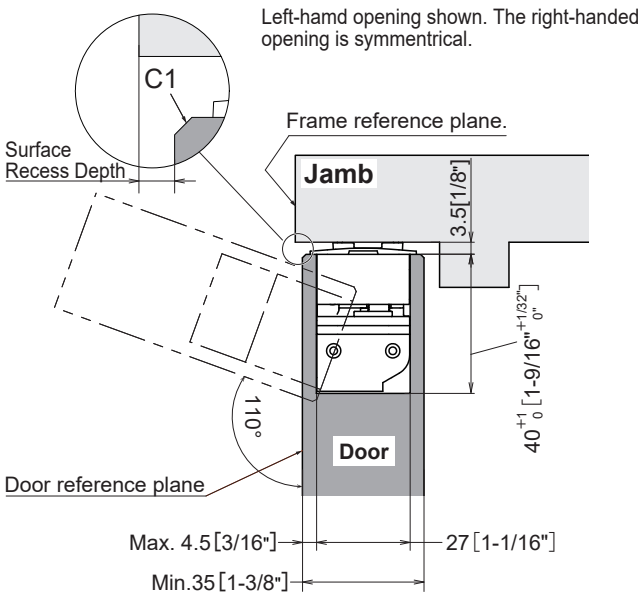

FOR YOUR SAFETY AND CORRECT INSTALLATION

- Caution**
- Prohibited**
- Required**

Caution: If not followed, injury or damage may result.

- ❗ Provide a doorframe that can withstand the weight and impact of opening and closing the door. **Only use the included screws in the package.** Do not use any other screws. Make sure to tighten them securely. If the mounting strength is insufficient, the door may fall and cause injury.
- ⊘ Do not use this product for any other purpose, or with doors that are outside the specifications of this manual.
- ❗ Follow the specified dimensions, specifications, and alignment of the door and frame. Warping, tilting or twisting of the frame or door may cause operation failure.
- ❗ This product is a part for architectural fittings. After installation, please check the function and safety of the final product. Please inform the end user how to use the product safely.
- ❗ Make sure to check the screws for slack at regular intervals (one month from first usage, half a year, and then one time every year is recommended).
- ❗ A door stopper must be installed so that the fully open position does not exceed 110°. Failure to do so will result in damage or breakage to the hinges, and the door may fall.
- ❗ Use in conjunction with a door closer is not recommended.

CUT OUT DRAWING FOR DOOR AND JAMB

Unit: mm[inch]

Left-hand opening shown. The right-handed opening is symmetrical.

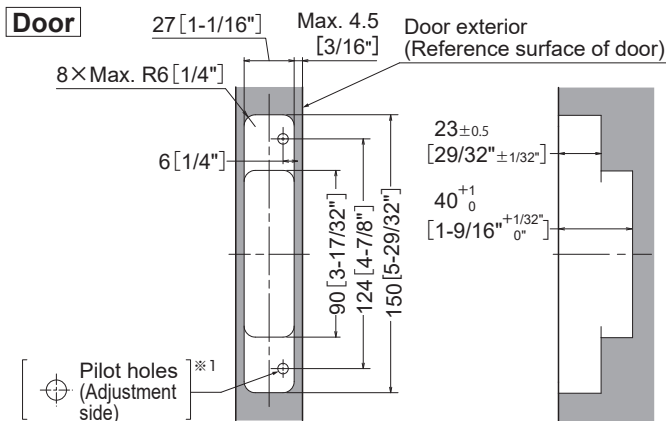

※1 : The diameter and depth of the pilot hole depends on the strength of the timber. Drill pilot holes before installing hinges. The position of the screw on the fixed side depends on the adjusted position of the hinge.

Marking Out Dimension Table

35mm[1-3/8"]Door(Machining margin 4mm[5-32"])	
Recess Depth	A : Adjustment screw pilot hole position
0	19 [3/4"]
1 [1/32"]	20 [25/32"]
2 [3/32"]	21 [13/16"]
3 [1/8"]	22 [7/8"]
4 [5/32"]	23 [29/32"]
5 [3/16"]	24 [15/16"]

36mm[1-13/32"]Door(Machining margin 4.5mm[3/16"])	
Recess Depth	A : Adjustment screw pilot hole position
0	19.5 [25/32"]
1 [1/32"]	20.5 [13/16"]
2 [3/32"]	21.5 [27/32"]
3 [1/8"]	22.5 [7/8"]
4 [5/32"]	23.5 [15/16"]
5 [3/16"]	24.5 [31/32"]

1 Hinge Installation

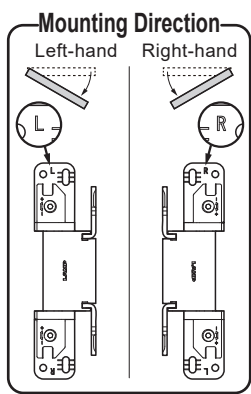

Installing Hinge on Door

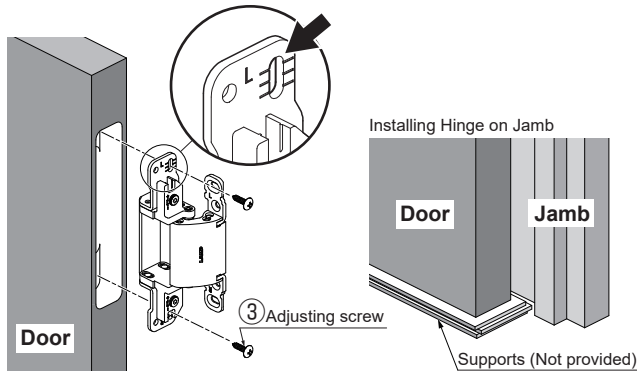

Installing Hinge on Jamb

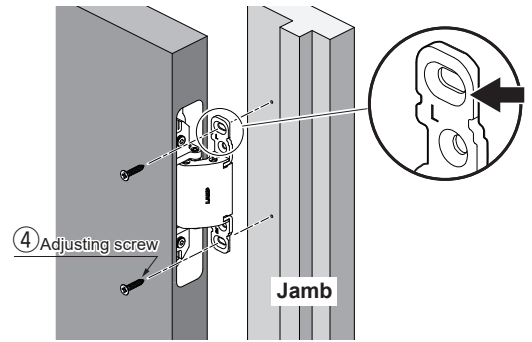

2 Adjusting Door Position

Vertical adjustment ($\pm 3\text{mm}$)

1 Please make sure that the screws are tightened after adjustment.

Depth adjustment ($\pm 2\text{mm}$)

Horizontal adjustment ($\pm 2\text{mm}$)

1 Turn both screws equally, a little at a time. Turning only one screw continuously may damage the hinge.

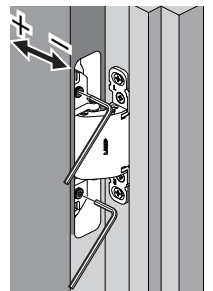
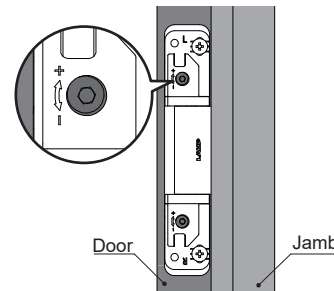
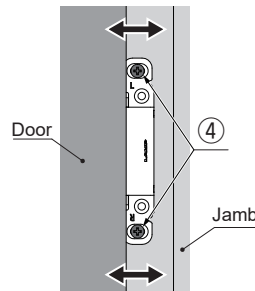
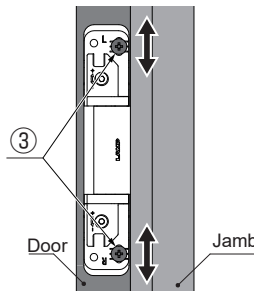
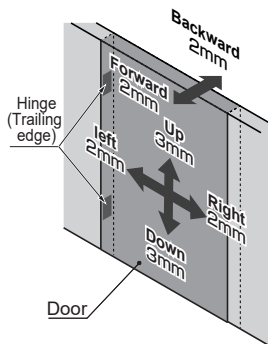

3 Hinge Installation

Installing Hinge on Door

1 Do not skip this step.

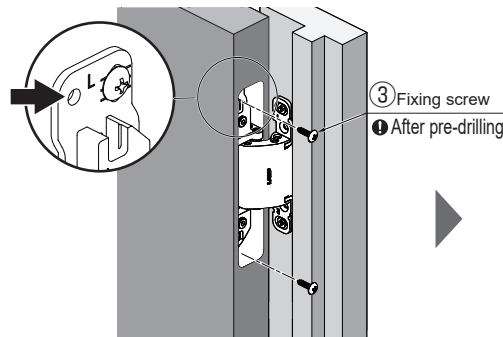

Installing Hinge on Jamb

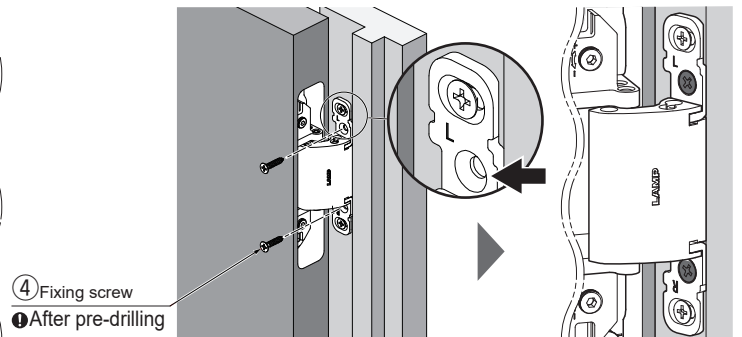

COVER INSTALLATION

Installing Hinge to Door

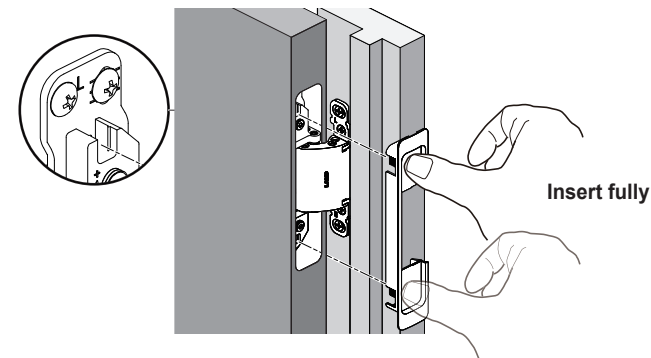

Installing Hinge on Jamb

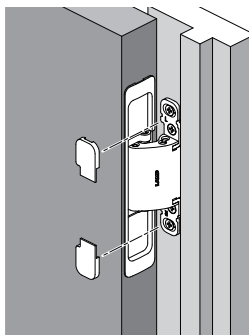

COVER REMOVAL

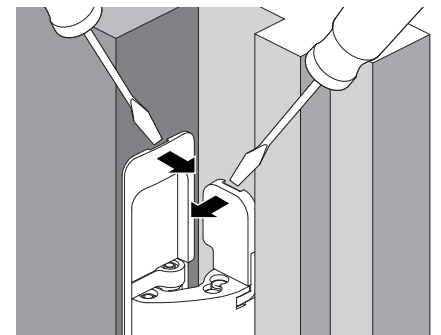

SUGATSUNE KOGYO CO., LTD.
Tokyo, JAPAN
Phone: +81 3 3866 2260
E-mail: export@sugatsune.co.jp

SUGATSUNE KOGYO (UK) LIMITED
Reading, UK
Phone: +44 1189 272 955
E-mail: sales@sugatsune.co.uk

SUGATSUNE EUROPE GmbH
Düsseldorf, GERMANY
Phone: +49 211 53612 900
E-mail: sales@sugatsune.eu

SUGATSUNE AMERICA, INC.
California, USA
Phone: +1 310 329 6373
E-mail: sales@sugatsune.com

Chicago, USA
Phone: +1 630 317 7072
E-mail: sales@sugatsune.com

SUGATSUNE CANADA, INC.
Montreal, CANADA
Phone: +1 514 312 5267
E-mail: support@sugatsune.ca

SUGATSUNE SHANGHAI CO., LTD.
Shanghai, CHINA
Phone: +86 21 3632 1858
E-mail: lamp@sugatsune.com.cn

Guangzhou, CHINA
Phone: +86 20 6639 3554
E-mail: lamp@sugatsune.com.cn

SUGATSUNE KOREA CO., LTD.
Incheon, KOREA
Phone: +82 32 220 0603
E-mail: sales@sugatsune-korea.co.kr

SUGATSUNE KOGYO INDIA PRIVATE LIMITED
Mumbai, INDIA
Phone: +91 9867299597
E-mail: sales@sugatsune.in
Delhi, INDIA
Phone: +91 9867299597
+91 11 45093636
E-mail: sales@sugatsune.in